

IF YOU...

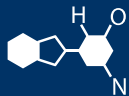

MIX IT. FILL IT. PACK IT. SHIP IT.

WE HAVE A **PRODUCT** FOR YOU

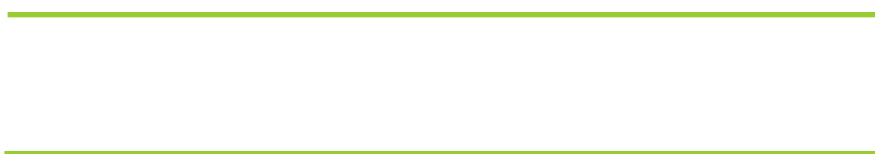

Part #	30W28B
Neck Width	28mm
Neck Finish	28-400
Color	Black
Material	PP



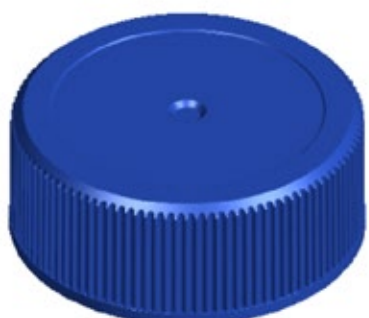
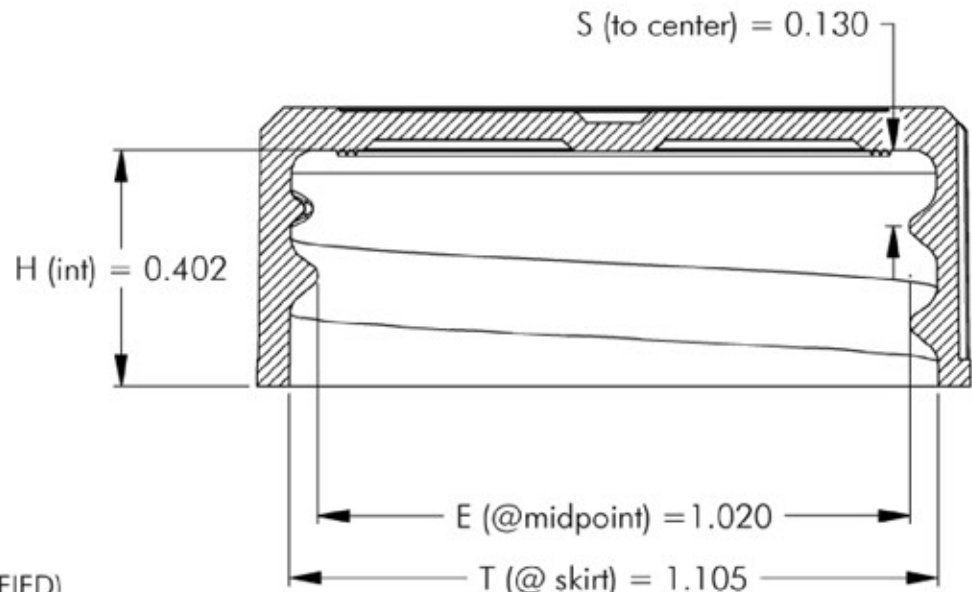
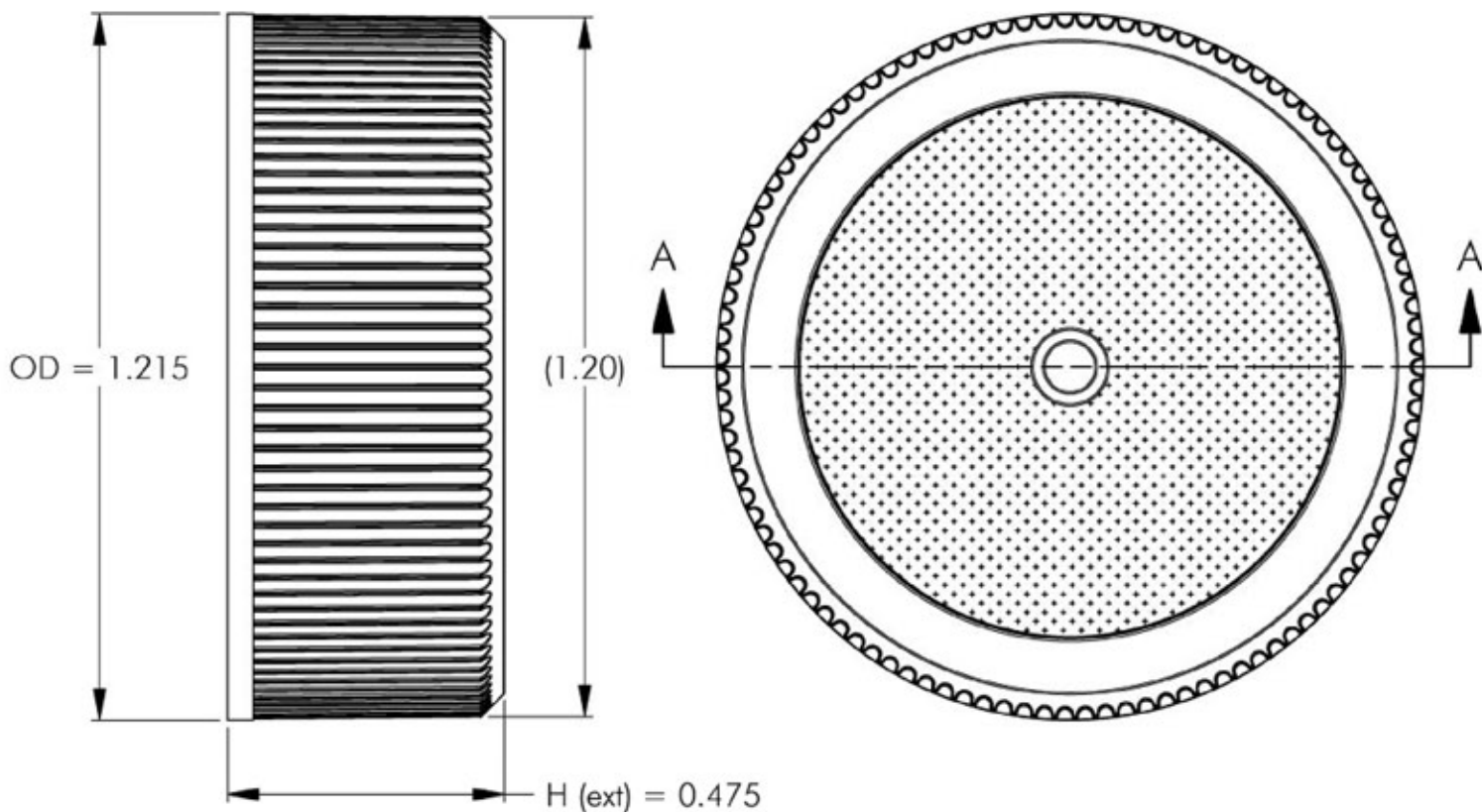

NOTES: (UNLESS OTHERWISE SPECIFIED)
 1. ALL DIMENSIONS ARE IN INCHES.
 2. TOLERANCE ON ALL DIMENSIONS IS $\pm 0.010"$.

1	12.13.05	prod. E dim	bz	PITCH (TPI): 6	# OF TURNS: 1-1/8	MATERIAL: POLYPROPYLENE
REV	DATE	DESCRIPTION	BY	DRAWING #: 28 - 400 - 62S		SCALE: 3 : 1
				DESCRIPTION: FINE RIB / MATTE FINISH TOP		
DRAWN BY: BEZ		DATE: 10.25.04	APPROVED BY: LRE	REV: 1		

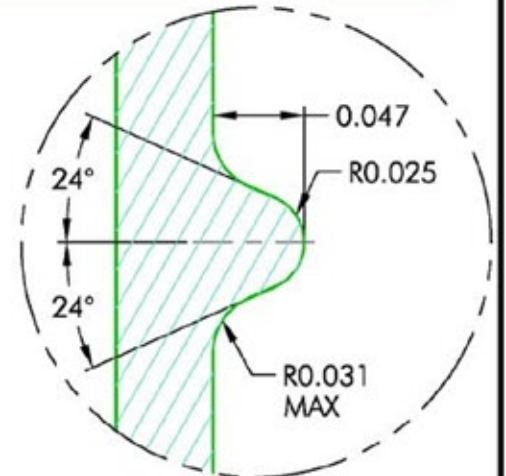
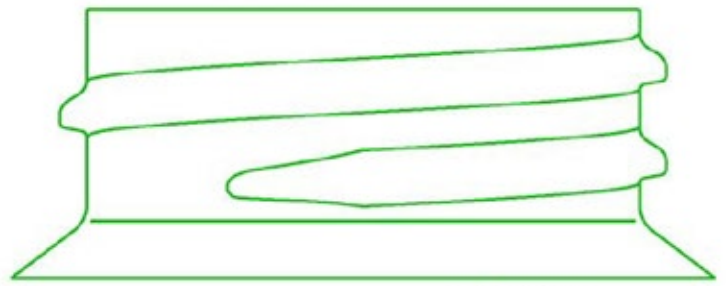
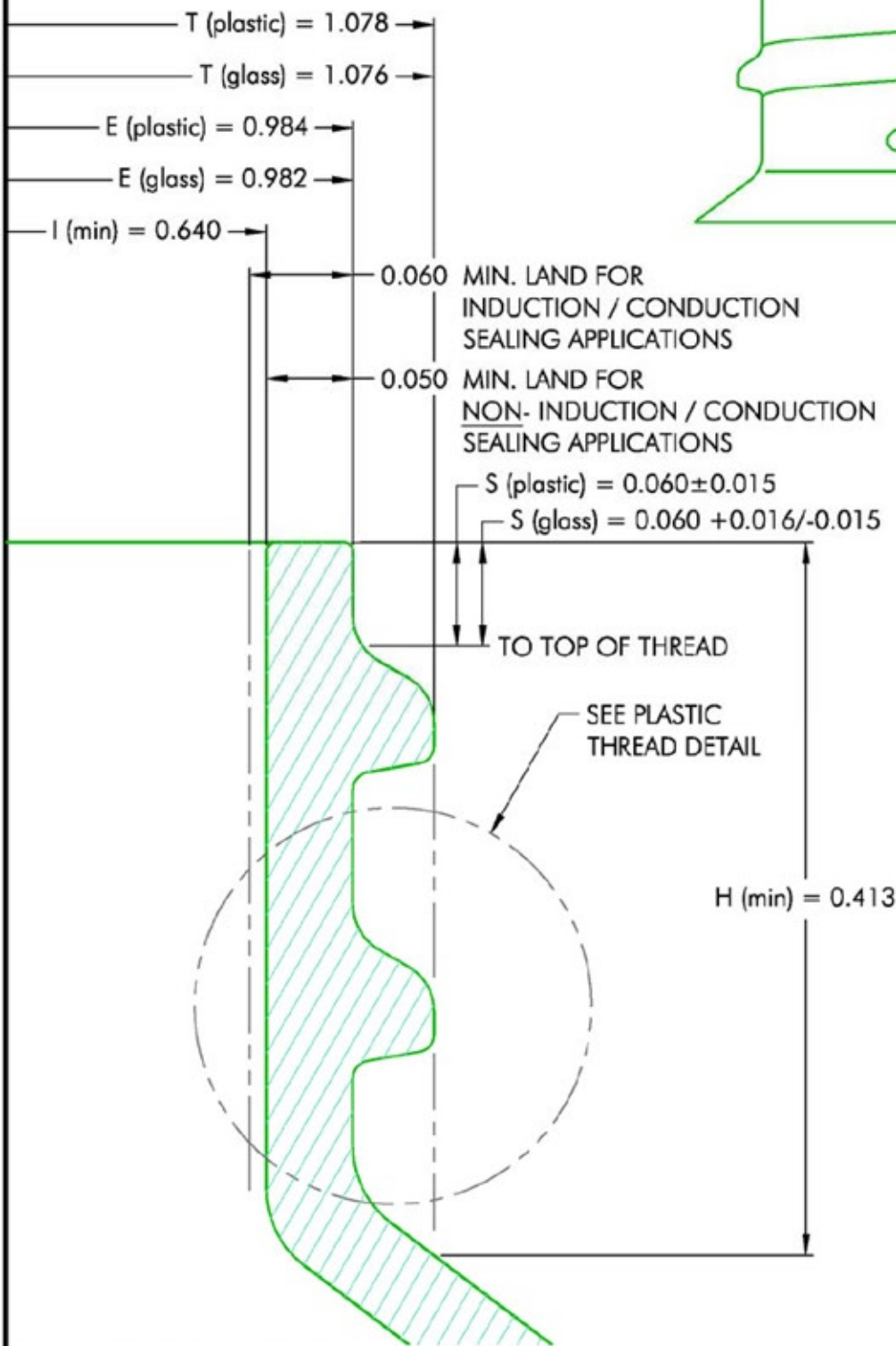

GLASS THREAD DETAIL
SCALE 10 : 1

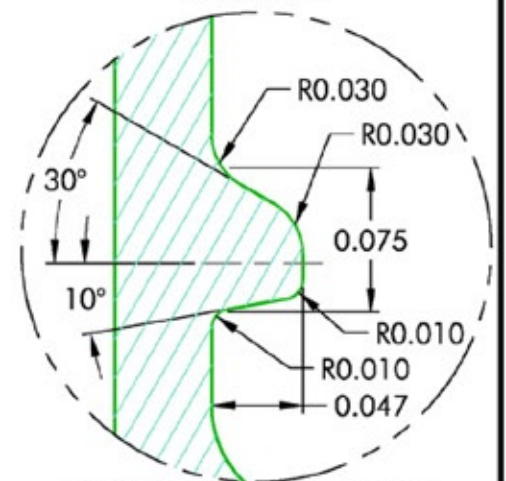

PLASTIC THREAD DETAIL
SCALE 10 : 1

MATERIAL	TOLERANCE
PP / PE	± 0.010
PET	± 0.006
GLASS	$+0.012 / - 0.013$

- NOTES: (UNLESS OTHERWISE SPECIFIED)
1. ALL DIMENSIONS ARE IN INCHES.
 2. TOLERANCE ON ALL DIMENSIONS GIVEN BY CHART.

#	00.00.00	DESCRIPTION	BY
REV	DATE		

The
CARY COMPANY
Est. 1895

PITCH (TPI): 6	# OF TURNS: 1-1/4	MATERIAL: PER CHART
DRAWING #: 28-400-FINISH		
DESCRIPTION: FINISH FOR USE WITH PCI 28-400 CLOSURES		
FILE: 28-400-FINISH.dwg	SCALE: 10 : 1	
DRAWN BY: BEZ	DATE: 02.01.96	APPRVD BY: LRE
REV: 0	BF	