

# IF YOU...

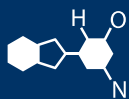

MIX IT. FILL IT. PACK IT. SHIP IT.

# WE HAVE A PRODUCT FOR YOU

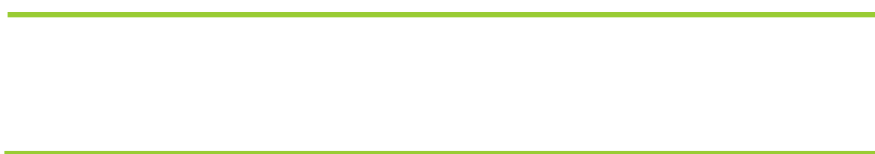



Part #	30WC20
Neck Width	20mm
Neck Finish	20-400
Color	Black
Material	PP
Case Pack	5,760 ea.
Pallet pack	115,200 ea. (20 Cases)

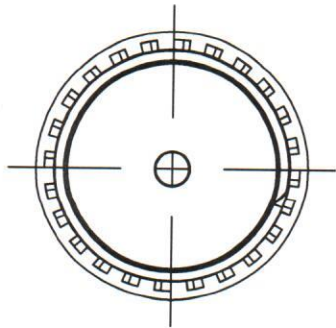
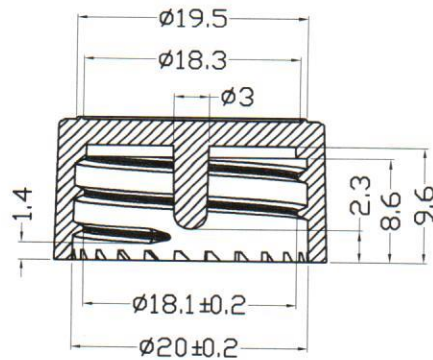
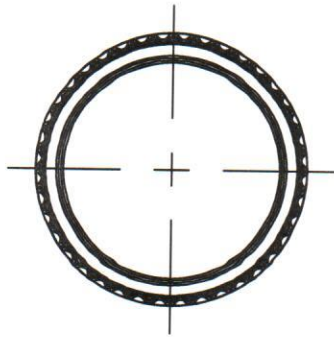



螺纹说明:  
 螺纹导程: 3.0mm (单头)  
 螺纹底脚宽: 1.2mm  
 螺齿高: 0.9mm  
 螺纹圈数: 3

					产品名称:		 Supplied By: <b>The Cary Company</b> Ph: 630-629-6600 www.thecarycompany.com			
					B5--盖子					
标记	处数	更改文件名	签字	日期	20mm		版次	V1.0	图幅	A4
设计			日期	2014. 3. 13	树脂材料	PP	比例	1:1	单位	mm
校对			日期		产品质量		第三角投影 			
审核			日期		共 页	第 页				
工艺			日期							